



OWNER'S MANUAL DISHWASHER

Before beginning installation, read these instructions carefully. This will simplify installation and ensure that the dishwasher is installed correctly and safely. Leave these instructions near the dishwasher after installation for future reference.

D1455**
D1454**
D1465**
D1464**
DC75*
DC65*



MFL66281401

www.lg.com

CONTENTS

CONTENTS	2
IMPORTANT SAFETY INSTRUCTIONS	
Important safety instructions.....	3
Read all instructions before use	4
Save these instructions.....	5
INSTALLATION INSTRUCTIONS	
Prepare cupboard opening	7
Preparation for electrical wiring	7
Preparing the dishwasher for installation.....	8
Installing the dishwasher in cupboard.....	8
Installation of drain hose.....	9
Installation of water inlet hose	10
Final check and assembling	10
How to level the dishwasher.....	10
PARTS NAME	11
FUNCTION OF CONTROL BUTTON	12
BEFORE USING FOR THE FIRST TIME	
Check and find water hardness level	17
Setting up the softening system level of your dishwasher	17
Salt Filling	18
Adding Rinse Aid	18
INFORMATION FOR ENERGY TEST	19
HOW TO USE AND OPERATE	
Daily use load	20
Cutlery Rack	21
Cutlery Basket	22
Lower Rack.....	22
Upper Rack.....	23
Adding Detergent.....	25
Refilling	26
Drying	27
Washing	27

Thank you for buying a LG Dishwasher.

Please read your owner's manual carefully, it provides instruction on safe installation, use and maintenance. Retain it for future reference.

Record the model and serial number of your Dishwasher.

Model No.

Serial No.

Date of Purchase

OPERATING SEQUENCE	28
PROGRAMME	29
USER MAINTENANCE INSTRUCTIONS	
Keeping the dishwasher	30
Filters	30
Lower Spray Arm	30
Upper Spray Arm	30
Water Inlet.....	30
TROUBLE SHOOTING GUIDE	
Before calling for service	31
Using SMARTDIAGNOSIS™	34
SPECIFICATION	35

IMPORTANT SAFETY INSTRUCTIONS

READ ALL INSTRUCTIONS AND EXPLANATION OF THE INSTALLATION BEFORE USE

⚠ WARNING

For your safety, the information in this manual must be followed to minimize the risk of fire or explosion, electric shock, or to prevent property damage, injury to persons, or death.

Your Safety and the safety of others are very important.

We have provided many important safety messages in this manual and on your appliance. Always read and obey all safety messages.

⚠ This is the safety alert symbol.

This symbol alerts you to potential hazards that can kill or hurt you and others. All safety messages will follow the safety alert symbol and either the word DANGER, WARNING or CAUTION.

These words mean:

⚠ DANGER

You will be killed or seriously injured if you don't immediately follow instructions.

⚠ WARNING

You can be killed or seriously injured if you don't follow instructions.

⚠ CAUTION

You may be slightly injured or cause damage to the product, if you do not follow instructions.

All safety messages will tell you what the potential hazard is, tell you how to reduce the chance of injury, and tell you what can happen if the instructions are not followed.

IMPORTANT SAFETY INSTRUCTIONS

■ Read all instructions before use

⚠ WARNING

To reduce the risk of fire, electric shock, or injury to persons when using the dishwasher, follow basic precautions, including the following:

- **Please read this manual carefully before using the dishwasher for the first time.**
- This manual contains very important notes regarding the installation, use and maintenance of your dishwasher.
- The manufacturer can not be responsible for problems caused by ignoring these safety and caution instructions.
- This dishwasher is designed for normal household use.
- **Do not use the dishwasher for industrial and commercial use, or other purpose.**
- **The appliance is not intended for use by young children or infirm persons without supervision.**
- **Check packaging and dishwasher immediately for signs of transport damage. If the appliance is damaged, do not put it into use but contact your supplier without delay.**
- This appliance is intended to be used in household and similar applications such as;
 - Staff kitchen areas in shops, offices and other working environments;
 - Farm houses;
 - By clients in hotels, motels and other residential type environments;
 - Bed and breakfast type environments.
- If this product is used for commercial purpose, it is not warranted. (Example: Public places such as restaurant, lodging house, training center, dormitory)
If the product is installed outside the normal service area, any cost of transportation involved in the repair of the product, or the replacement of a defective part, shall be borne by the owner.

► During installation

- **Electrical connection must be in accordance with the rating label.**
- Electrical safety is only guaranteed when the earth system of your house is in accordance with the related local regulations. **(Do not use an extension cable or cord.)**
- If the hot water exceeds 65°C, adjust the water heater setting. If the hot water temperature can not be maintained below 65°C, the dishwasher must be connected to cold water.
- If power supply cord is damaged, it must only be replaced by the manufacturer or its service agent or a similar qualified person in order to avoid a hazard.
- This appliance must be positioned so that the plug is accessible.
- The appliance is to be connected to the water mains using new hose-sets and that old hose-sets should not be reused.

► During use

- **Only suitable household utensils should be placed in the dishwasher.**
- **(Please avoid utensils; that are non-heat-resistant, metal decorated, etc.)**

IMPORTANT SAFETY INSTRUCTIONS

■ Read all instructions before use

⚠ WARNING

To reduce the risk of fire, electric shock, or injury to persons when using the dishwasher, follow basic precautions, including the following:

- **Do not use any kinds of solvent in your dishwasher. They may cause an explosion or fire.**
- **Do not spray water on the appliance. It may cause the failure of electric parts or electric shock.**
- **Do not push down or sit on the inner door when the door is opened. It may cause the deformation or failure of your dishwasher.**
- **Do not use the detergent for hand washing. The detergent for dishwasher should be used for normal operation.**
- This appliance is fitted with a safety function that automatically stops the operation of the dishwasher when it is exposed to heavy disturbance on its mains.
- Dishwasher detergents are strongly alkaline. They can be extremely dangerous if swallowed.
Avoid contact with skin and eyes and keep children away from the dishwasher when the door is open. Check that the detergent receptacle is empty after completion of the wash cycle.

► Child Safety

- Controls may be locked using Child Lock mode to prevent all the settings from being changed by a child.
 - **Keep children away from detergents and rinse-aids.**
 - **Do not allow children to operate the dishwasher.**
 - **Young children should be supervised to ensure that they do not play with the appliance.**
- All batteries (whether installed or attached) should not be exposed to excess heat like sunlight or similar source.

■ Save these instructions

GROUNDING INSTRUCTIONS

This appliance must be grounded. In the event of malfunction or breakdown, grounding will reduce the risk of electric shock by providing a path of least resistance for electric current.

This appliance is equipped with a cord having an equipment-grounding conductor and grounding plug. The plug must be plugged into an appropriate outlet that is properly installed and grounded in accordance with all local codes and ordinance.

- Do not use an adapter this will defeat the grounding plug.
- If you don't have the proper outlet, consult an electrician.

IMPORTANT SAFETY INSTRUCTIONS

⚠ WARNING

Improper connection of the equipment-grounding conductor can result in electric shock. Check with a qualified electrician or serviceman if you are in doubt as to whether the appliance is properly grounded. Do not modify the plug provided with the appliance - if it does not fit the outlet, have a proper outlet installed by a qualified electrician.

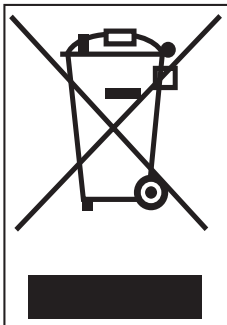

Disposal of your old appliance

1. All electrical and electronic products should be disposed of separately from the municipal waste stream via designated collection facilities appointed by the government or the local authorities.
2. The correct disposal of your old appliance will help prevent potential negative consequences for the environment and human health.
3. For more detailed information about disposal of your old appliance, please contact your city office, waste disposal service or the shop where you purchased the product.

⚠ CAUTION

CAUTION concerning the Power cord

- Most appliances recommend they be placed upon a dedicated circuit; that is, a single outlet circuit which powers only that appliance and has no additional outlets or branch circuits. **Check the specification page of this owner's manual to be certain.**
- **Do not overload wall outlets.** Overloaded wall outlets, loose or damaged wall outlets, extension cords, frayed power cords, or damaged or cracked wire insulation are dangerous. Any of these conditions could result in an electric shock or fire.
- **Periodically examine the cord of your appliance,** and if its appearance indicates damage or deterioration, unplug it, discontinue use of the appliance, and have the cord replaced with an exact replacement part by an authorized servicer.
- **Protect the power cord from physical or mechanical abuse,** such as being twisted, kinked, pinched, closed in a door, or walked upon. Pay particular attention to plugs, wall outlets, and the point where the cord exits the appliance.
If the appliance is supplied from a cord extension set or an electrical portable outlet device, the cord extension set on electrical portable outlet device must be positioned so that it is not subject to splashing or ingress of moisture.

⚠ CAUTION

The instructions shall state the substance of the following :

This appliance is not intended for use by persons (including children) with reduced physical, sensory or mental capabilities, or lack of experience and knowledge, unless they have been given supervision or instruction concerning use of the appliance by a person responsible for their safety.

Children should be supervised to ensure that they do not play with the appliance.

INSTALLATION INSTRUCTIONS

⚠ WARNING

- A qualified electrician/plumber or competent person should carry out any electrical/plumbing work required to install this appliance.

■ Prepare cupboard opening

1. This dishwasher is designed to fit the size shown as below.
2. Select a location as close to sink as possible for ease of connection to the water and drain pipes.
3. To ensure good drainage, the dishwasher should not be installed more than 3 meters away from the sink.
4. If dishwasher is installed in a corner, a minimum of 5cm of space is required between the washer and an adjacent cabinet or wall.

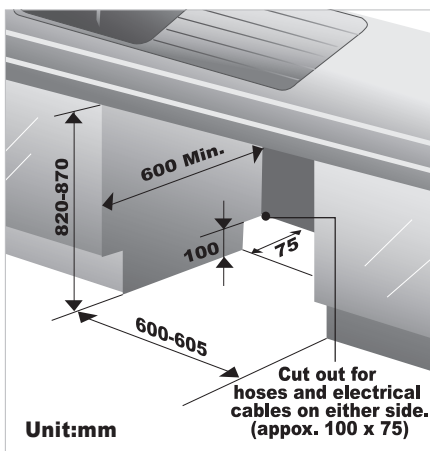

⚠ CAUTION

- Any bare wood surrounding the dishwasher should be sealed with a waterproof paint or sealant to prevent swelling.

■ Preparation for electrical wiring

⚠ CAUTION

- For personal safety, remove house fuse or open circuit breaker before installation.
- Do not use an extension cord or adapter plug with this appliance. Electrical and earthing connections must comply with the national electrical code/provincial and municipal code and/or other local codes.

1. This appliance must be supplied with correct rating voltage and hertz as shown on instruction manual, and connected to an individual, properly earthed branch circuit, protected by a minimum 15 amp circuit breaker or time delay fuse. Wiring must be 2 wires with Earth.
2. The power plug must be in a accessible location adjacent to and not behind the dishwasher and within 1.2 meters of the dishwasher side. (See page 9 Fig.A)
3. The power plug must be correctly earthed, if in doubt, have it checked by a qualified Electrician. No other appliance should be connected to the same plug outlet by a double adapter or similar plug.

Dangerous voltage

5036

To indicate hazards arising from dangerous voltages.



Note- in case of an application warning sign, the rules according to ISO 3864 should be adhered to.

INSTALLATION INSTRUCTIONS

■ Preparing the dishwasher for installation

1. Lay the dishwasher on its back.
2. Adjust the legs to the required height as shown in below figure.

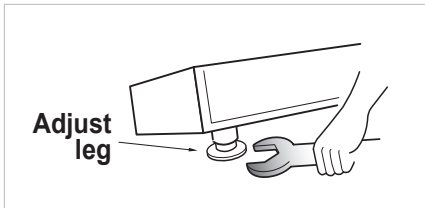

3. To reduce noise attach the strip to the machine base.

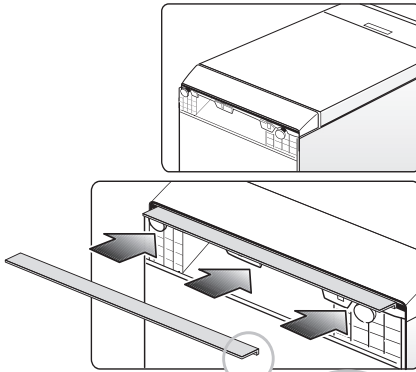

Remove the adhesive cover and attach the strip to the machine base, hiding the legs. Trim the edges if desired.

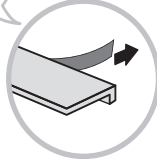

■ Installing the dishwasher in cupboard

1. Before sliding the dishwasher into the cupboard opening, all necessary height and balancing adjustments should be made using a spanner.
2. Slide the dishwasher into the cabinet, opening carefully. Make sure that the drain hose inside the cabinet is not kinked or stretched.

⚠ CAUTION

- If the height of the cupboard is below 850mm, you should remove the top table by unscrewing the 2 screws. (Two from rear)

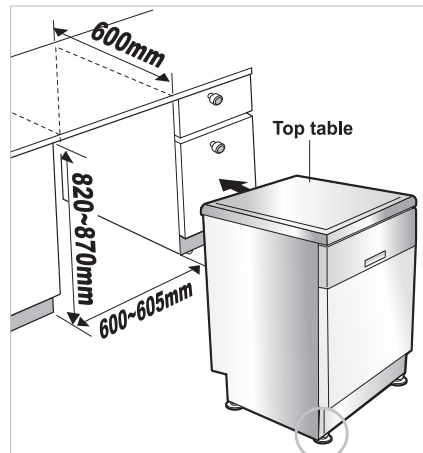

The bottom of the strip should touch the floor.

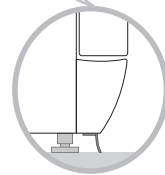

INSTALLATION INSTRUCTIONS

■ Installation of drain hose

1. If the end of drain hose does not fit to the drain line, use a rubber connector(not supplied) that is resistant to heat and detergent.
2. This should be available from a plumbing shop or DIY merchants.
3. There are two typical connections as shown in Figure A, B.

The S trap spigot must be drilled out cleanly and free of obstruction to its maximum internal diameter, if used for drainage.

To prevent siphoning, one of the following methods must be used:

- ▶ When the drain hose is connected to a sink S trap or waste disposal unit, the hose must be looped up to the underside of the bench top and secured.

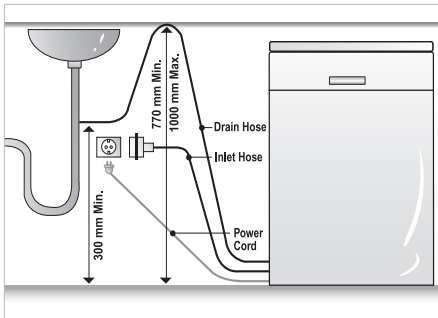

Fig. A

- ▶ When the drain hose is connected to a separate standpipe, it is essential that an airtight connection be made. Refer to Fig.B

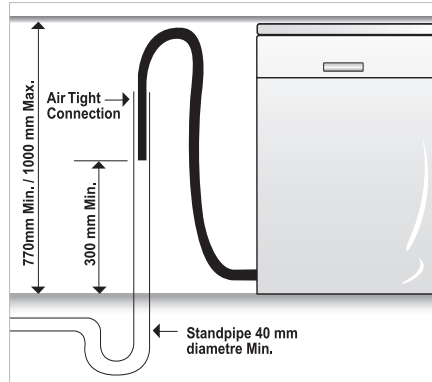
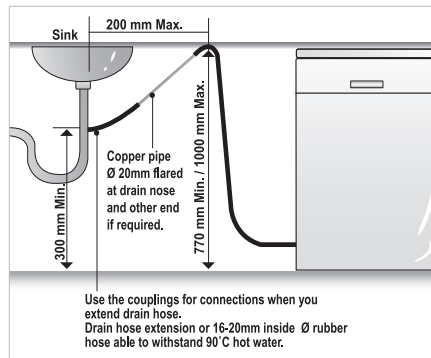

Fig. B : Drainage connection - stand pipe.

Drain hose Extension

Extend drain hose as shown below.



⚠ CAUTION

- When you connect or extend drain hose, **make sure that drain hose is not kinked.** (Bends should have a 40 mm radius.)

INSTALLATION INSTRUCTIONS

■ Installation of water inlet hose

- ▶ Connect the water supply hose to the water tap. (Fig. A)
- ▶ Some models consist of an inlet valve and hose. (Fig. B)
After connecting the inlet hose to the tap, turn on the tap to flush out foreign substances (dirt, sand or sawdust) in the water lines. Let water drain into a bucket, and check the water temperature. Connect the supply hose to the water inlet valve.

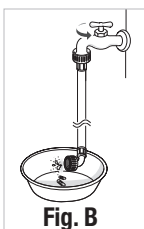
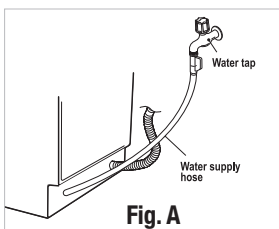

- This dishwasher may be fed with either hot or cold water. If the water can not be maintained below 65°C, the dishwasher must be connected to cold water.
- When connecting, you may use sealant tape or sealing compound to avoid water leaks.
- Make sure that the line is not kinked or sharply bent.
- It is recommended that the new inlet hose be used and not the existing or old hose.

■ Final check and assembling

1. Securely hand tighten supply hose to the water supply.
Plug the power supply cord into an earthed electrical point and switch on.
2. After installing and prior to using the dishwasher with crockery, we recommend that you use the dishwasher on **Quick** mode to rinse through. At this stage it is useful to ensure that there are no operating problems or water leaks.
When the dishwasher is used for the first time, there may be a loud noise, if this happens, turn off the power and restart the dishwasher.

■ How to level the dishwasher

After installing the dishwasher, you may notice a slight sticking of the door to the dishwasher, when you open or close the door. If this does happen you need to adjust the level of the dishwasher.

Water leakage from the door can occur if the product is not leveled correctly.

Case 1. In case the door is slanted to the right

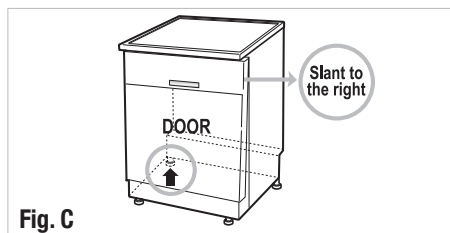

Fig. C

- If the door slants to the right, see fig. C and follow these instructions:
 - 1) Unscrew(counter-clockwise) the left leg of the back side and correct the level.
 - 2) Check the opening of door and repeat if necessary until the door opens and closes properly.
- When the product is correctly leveled, there should be no slant, stickiness or friction sound.

Case 2. In case the door is slanted to the left

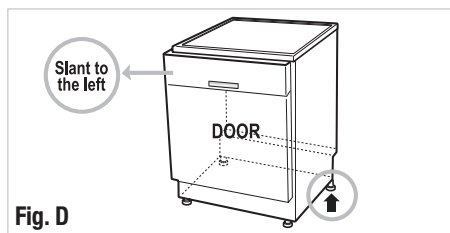
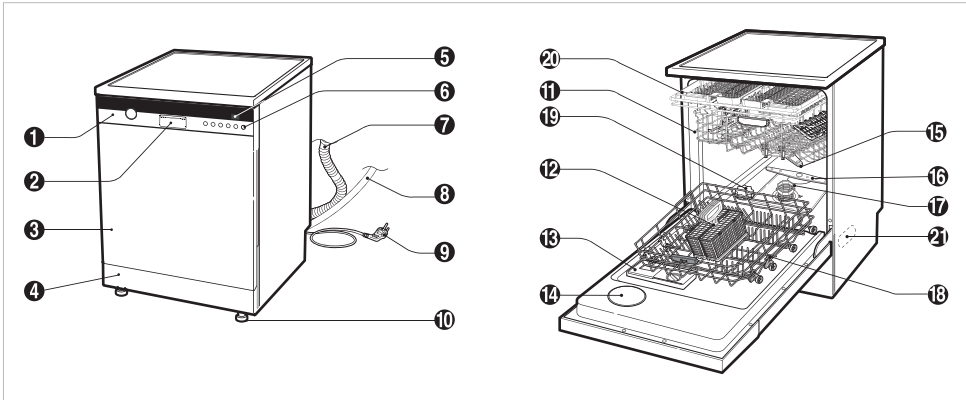

Fig. D

- If the door slants to the left, see fig. D and follow these instructions:
 - 1) Check the opening of door if there still remains sticky or friction sound.
 - 2) Check the opening of door and repeat if necessary until the door opens and closes properly.
- When the product is correctly leveled, there should be no slant, stickiness or friction sound.

PARTS NAME



1. Control Panel
2. Door Handle
3. Front Cover
4. Lower Cover
5. Display Window
6. Power Button
7. Drain Hose
8. Inlet Hose
9. Power Cord
10. Adjustable Leg

11. Upper Rack
12. Cutlery Basket
13. Detergent And Rinse Aid Dispenser
14. Vapor Vent Cover
15. Upper Spray Arm
16. Lower Spray Arm
17. Filter ASM
18. Lower Rack
19. Salt Container Cap
20. Cutlery Rack
21. Steam Nozzle

Accessories



Funnel

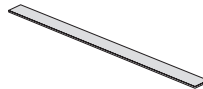

Noise Strip

※ The appearance and specifications may vary without notice.

FUNCTION OF CONTROL BUTTON

■ MODEL : D1455**

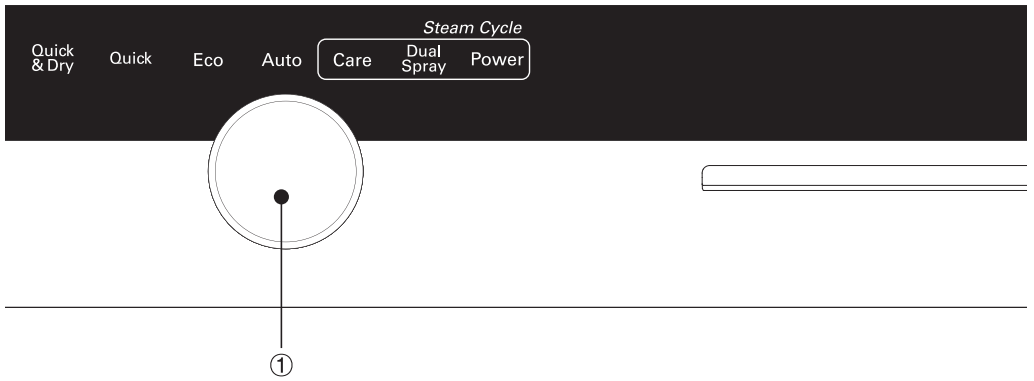

■ MODEL : D1454**

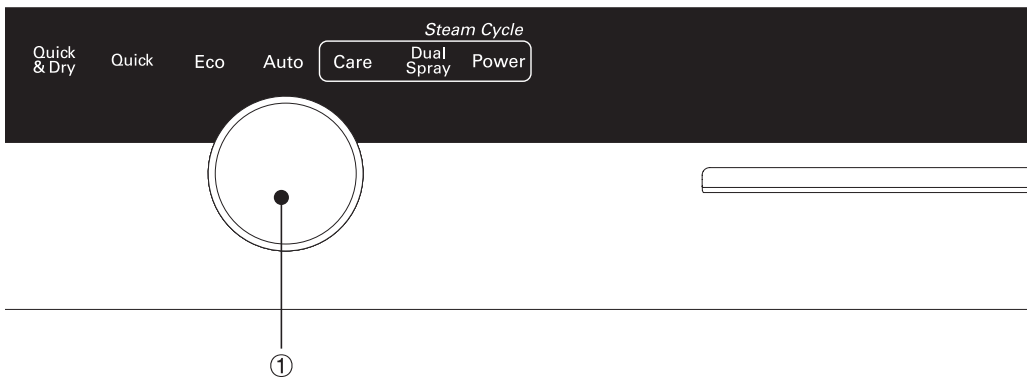

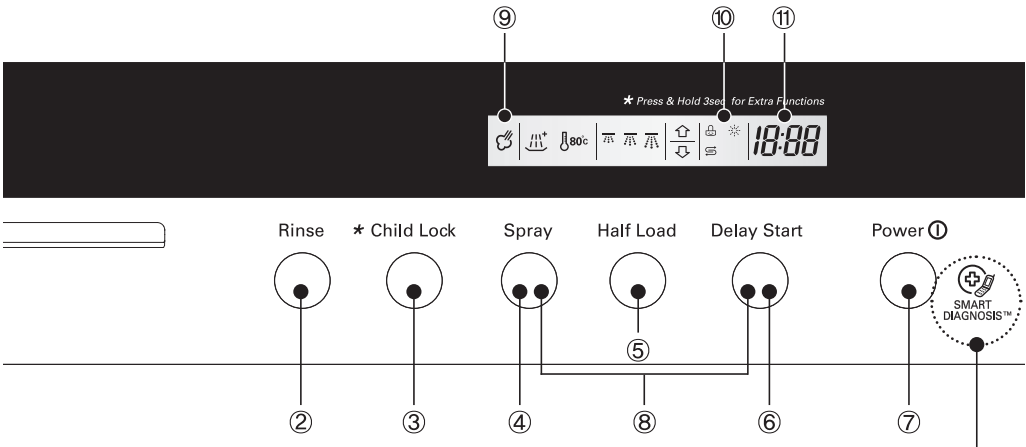

SMARTDIAGNOSIS™ function is available only for the products with a **SMARTDIAGNOSIS™** mark. (Refer to Page 34.)

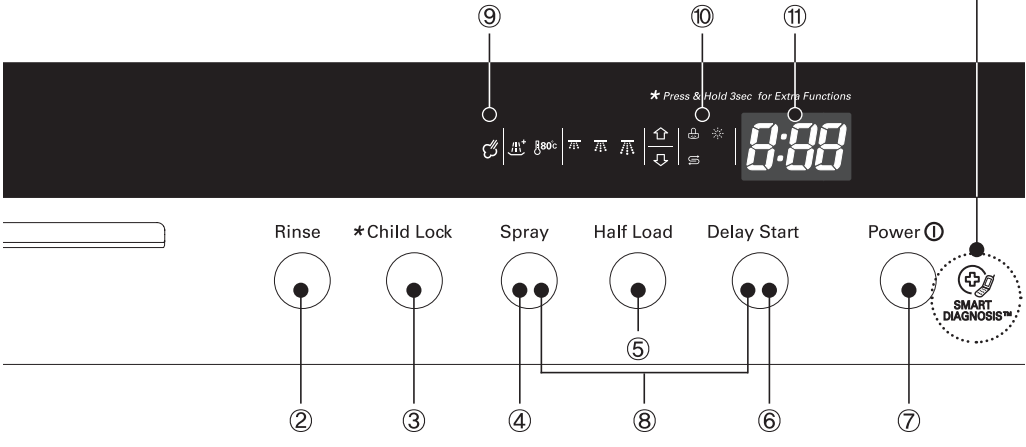

FUNCTION OF CONTROL BUTTON

■ MODEL : D1465** DC75*

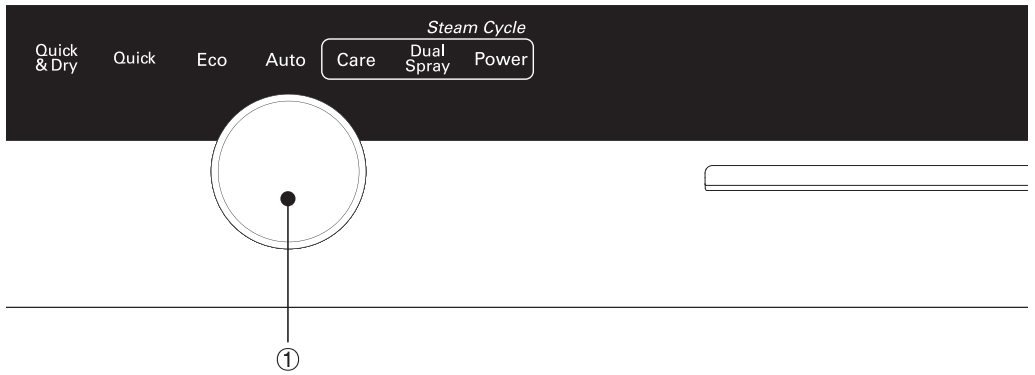

■ MODEL : D1464** DC65*

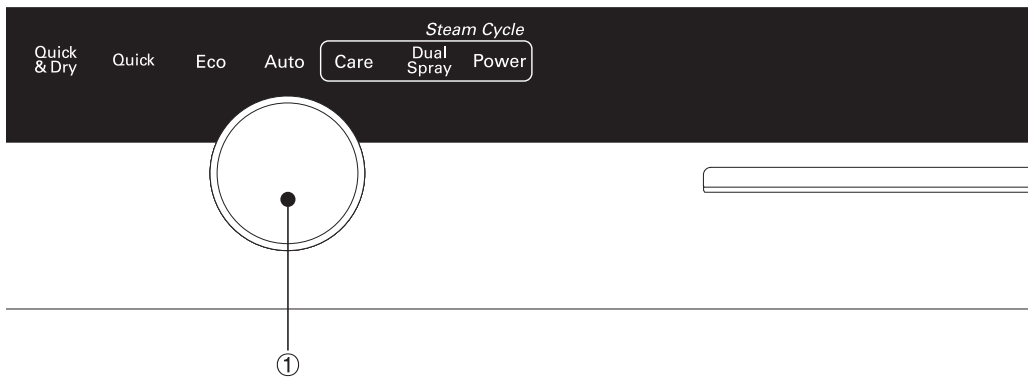

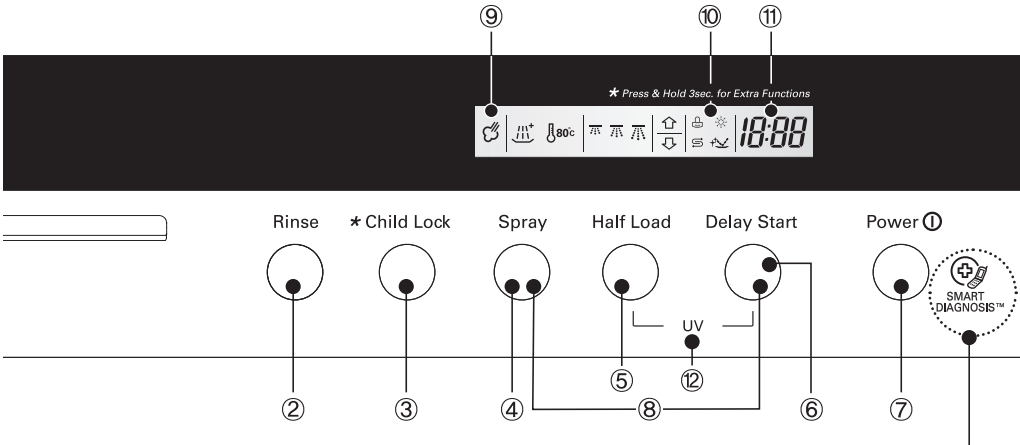

SMARTDIAGNOSIS™ function is available only for the products with a **SMARTDIAGNOSIS™** mark. (Refer to Page 34.)

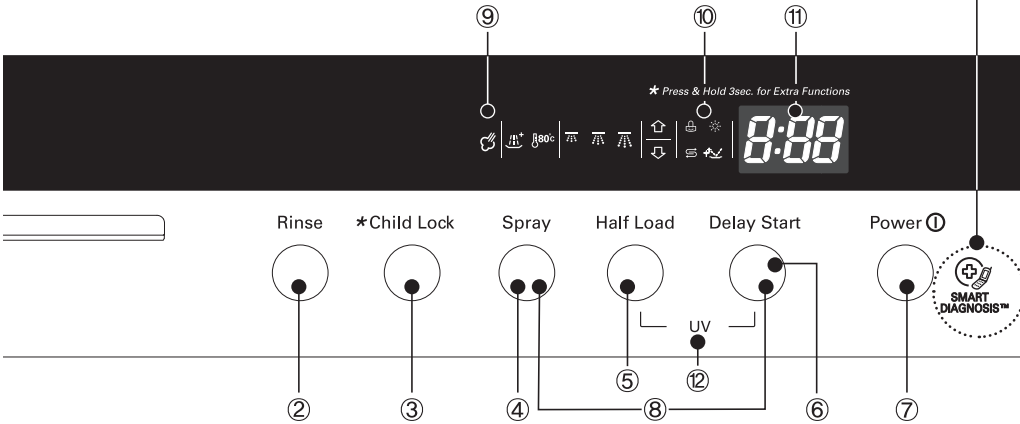

FUNCTION OF CONTROL BUTTON

① Programme

- Press the cycle that corresponds to your desired wash cycle.

② Rinse

- Repeated pressing of the **Rinse** button will select Extra Hot, Rinse+, Extra Hot & Rinse+.
- If you select the **Extra Hot (80°C)** function, the operating temperature will be up to 80 °C. (Eco, Auto, Steam Care, Steam Dual Spray, Steam Power)
- When you select **Rinse+** () an additional rinse cycle is added.



③ Child Lock ()

- Used to lock or unlock the control buttons to prevent all the settings from being changed by a child.
- To activate or release the **Child Lock** function, press the **Child Lock** button for 3 seconds while the dishwasher is in operation.
- All controls will be disabled except the **Child Lock** and **Power** buttons.
- Turning off the dishwasher will not reset the **Child Lock** function. You must release the **Child Lock** before you can operate the dishwasher.

④ Spray

- With each press, the level of water jet is changed to **Medium** (), **Soft** () and **Strong** () in a sequence. (Only Steam Care and Steam Dual Spray)

⑤ Half load

- In case of small load, use upper or lower rack only to save energy.
- With each press, select **Upper** () or **Lower** () rack only. (Except Quick & Dry, Steam Power)
- In case you don't select this button, the machine always works vario washing, which operates upper and lower spray arm alternately.

⑥ Delay Start

- If you want to delay the start of selected programme, press this button.
- Pressing this button will increase time by 1 hour.
- The delay start time can be adjusted from 1 hour to 19 hours.

⑦ Power

- For operating, press this button first for power on.
- After operating, this button automatically switches off for safety and energy saving.
- In case of irregular surge disturbance to the machine, the power may be automatically turned off for safety.

⑧ Beep On/Off

- The dishwasher must be switched on.
- The beep on/off function can be set by pressing the **Spray** and **Delay Start** button simultaneously for a few seconds.

⑨ Steam ()

- The **Steam** symbol light will stay on when the **Steam** course has been selected.

⑩ Indicator

- | | | | |
|---|-----------------------------|---|--------------------------|
|  | • Child Lock. |  | • Refill with rinse aid. |
|  | • Refill with special salt. |  | • UV |

⑪ Time Left

- Before starting, the display window shows the running time of the selected programme.
- After starting, the display window shows the remaining time.
- If the dishwasher has a trouble, the trouble type is displayed. (OE, FE, IE, AE, HE, LE, tE, nE)
- If these error letters are displayed, please refer to the trouble shooting guide page 32 and follow the guide.

⑫ UV

- If you want to sterilise the dishes, press **Half Load** and **Delay Start** button.
- After drying cycle, steriliser will be performed by UV lamp.
- At this time, St code is displayed in display window.
- When you open the door of dishwasher, UV lamp is turned off.
- ※ Don't look at the lamp directly with the naked eye.

BEFORE USING FOR THE FIRST TIME

Hardness setting

※ You have to check your water hardness and set the softening system level before operating your dishwasher.

Step 1. Check and find water hardness level

■ Method 1

- 1) Check the water hardness in your area.
(Your water utility company can help you with this.)
- 2) Set the softening system level of your dishwasher according to the water hardness level.
Refer to Step 2.

■ Method 2

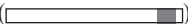
- 1) Check your water hardness by using test strip. 
- 2) Test Procedure
 - ① Immerse **all reaction zones** of the test strip **for approx.1sec (not in running water!)**.
 - ② Shake off excess liquid from the strip and **wait for 1min.**
 - ③ Check the water hardness color from the strip.(refer to the wrapper)

< Water hardness level >

The value of hardness	Hardness range					Water quality	Softening system level
	°d	°e	°f	mmol/l (Ca+Mg)	mg/l Ca		
0	<4	<5	<7	<0.7	<29	soft ↑↓ very hard	H0
75	4-7	5-9	7-13	0.7-1.3	29-50		H1, H2
125	7-14	9-17.5	13-25	1.3-2.5	50-100		H3, H4
250	14-21	17.5-26	25-38	2.5-3.8	100-150		H5, H6
375	>21	>26	>38	>3.8	>150		H7

1 °e = 14.25 mg/l CaCO₃

1 °f = 10 mg/l CaCO₃

1 °d = 10 mg/l CaO (=1,78 °f) (=1,25 °e)

- 3) Set the softening system level of your dishwasher according to the water hardness level.
Refer to Step 2.

Step 2. Setting up the softening system level of your dishwasher

Adjust the water softener to the setting corresponding to the water hardness level in your area.

The water softener has 8 adjustment levels.

The dishwasher is programmed at the factory for a water hardness level of H4.

This can be checked and altered by using the buttons on the control panel.

1. First, ensure the dishwasher is switched off.
2. Press **Half Load** and **Power** button simultaneously and keep them pressed.
3. To change the setting:
Simply press the **Half Load** button, then the figure will change one by one.
The display will change between H0 and H7.
4. Once the hardness setting is correctly adjusted, press the **Delay Start** button.
The hardness setting is then saved.

BEFORE USING FOR THE FIRST TIME

Step 3. Salt Filling

This model has a water softener to soften hard water. Please read these notes carefully for correct operation.

In order to provide satisfactory rinsing results, the dishwasher requires soft water, i.e., containing little or no lime, otherwise water stains will be left behind on the dishes and interior containers. If the tap water exceeds a certain level of hardness, it must be softened, i.e., decalcified. This is achieved by adding a special salt to the water softener inside the dishwasher. The required amount of salt is set up according to how hard your tap water is.

■ Filling with Salt

Fill the regenerating salt container **before starting the washing programme.**

Once you have filled with salt you must run the **Quick** course immediately to remove salt and salt water around the tub in order to prevent corrosion.

- Remove lower rack and unscrew the cap of salt container.
- Before using your dishwasher for the first time, it is necessary to **Pour 1.5kg of salt and 1 litre of water** in to the container. **Otherwise salt refill lamp always turn on during operation.** Use a funnel for ease and clean filling, ensuring that coarse salt or regenerating salt intended for dishwashers is used.
- After filling, wipe off any spilled salt to seal the cap properly.
- Screw the cap tightly to prevent any suds from penetrating into the container.

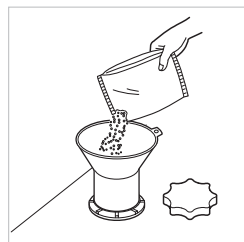

Step 4. Adding Rinse Aid

■ For filling

To fill the Rinse Aid chamber, push the rinse aid button. Fill the container to the maximum level with a good quality Rinse Aid, then close the cap.

The Rinse Aid is automatically dispensed during the final rinse cycle.

The dosage is factory set to suit most installations. If, after washing, you notice cloudy spots, streaks or water marks on your glassware, it may be necessary to increase the setting. To do this, remove the cap and rotate the indicator arrow to a higher setting then replace the cap. If the glass is smeared or foam is present on the bottom of the glass or the bottom of the machine, select a lower setting.



INFORMATION FOR ENERGY TEST(EN50242)

- Appliance loaded in accordance with standard specifications.
 - Capacity : 14 place settings
 - Standard course : Eco
 - Rinse Aid setting : 5
 - Reference cleaner : 35g of detergent onto the inside surface of the door.
 - Height-adjustable Rack-U must be inserted into the uppermost position.
 - It is the most efficient programme in terms of its combined energy and water consumption for that type of tableware.

Program	Time in minutes	Water in Liter	Energy in KWh
Eco	225	9	0.92

1. Cutlery Basket

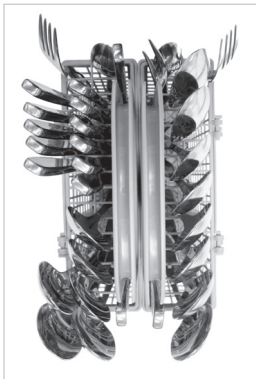

1 2 3 4 5 6 7 8

4	1		4
8	8	8	8
8	8	8	8
8	8	8	8
8	8	8	8
8	8	8	8
3	3	3	3
3	3	3	3
3	3	3	3
3	3	3	3
3	3	3	3
3	3	3	3
3	3	3	3
3	3	3	3

2. Cutlery Rack

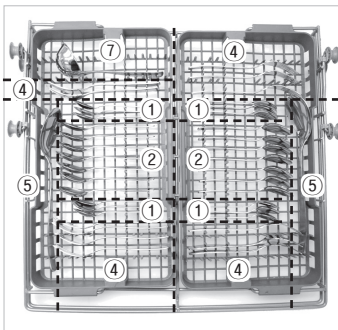

1 2 3 4 5 6 7

3. Upper Rack

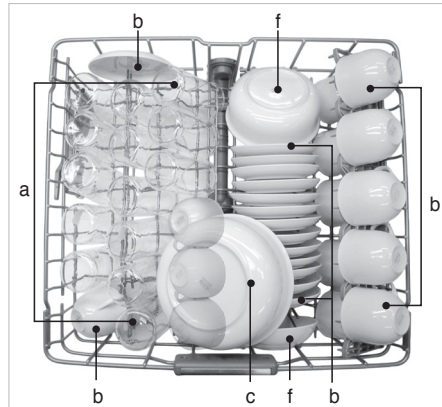

a	Milk	b	Tea	c	Meat
d	Egg	e	Oat	f	Spinach
g	Margarine				

4. Lower Rack

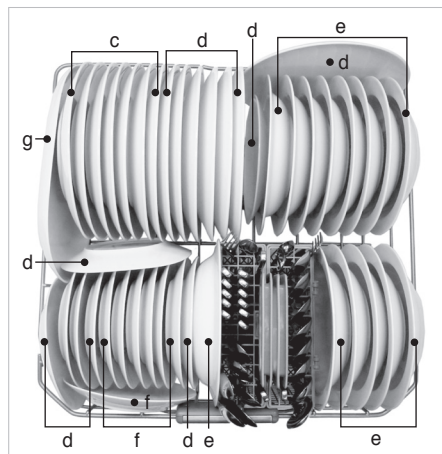

a	Milk	b	Tea	c	Meat
d	Egg	e	Oat	f	Spinach
g	Margarine				

HOW TO USE AND OPERATE

■ Daily use load

1. Cutlery Basket

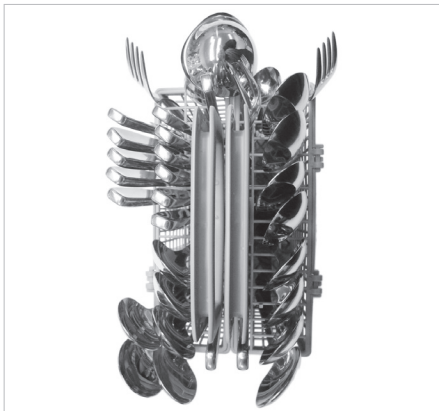

3. Upper Rack



2. Cutlery Rack

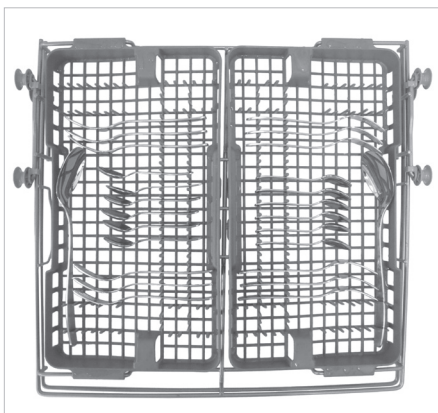

4. Lower Rack

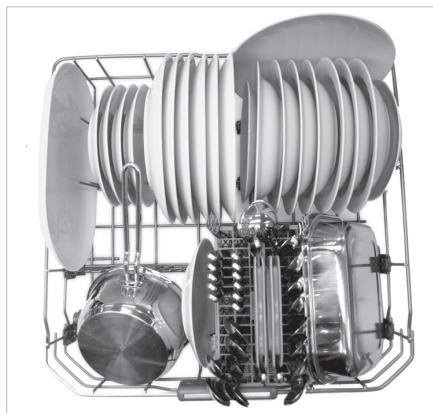

▲ CAUTION

- Do not use the pot and pan with plastic handle.
- Poor washing for smudges of waterproof or long lasting lipsticks on the glass.

HOW TO USE AND OPERATE

For better washing performance, always load the dishwasher according to the instructions.

- Before loading items into the dishwasher.
 - Clean off large particles of food, in particular insoluble items such as bones, pips etc.
 - Items with burnt on food should be soaked prior to loading in the dishwasher.
- While you load items into the dishwasher.
 - Load all items with the opening down. (Make sure that water does not collect in a deep base.)
 - Deep based items should be placed at an angle to help water run off and dry properly.
 - Make sure that all items do not touch each other.
- Take care not to obstruct the rotation of spray arms.
- Plastic items do not dry as well as steel or porcelain items.

NOTE

Non Dishwasher Safe Items

The combination of high water temperatures and dishwasher detergent may damage particular items, therefore we do not recommend using the dishwasher to wash the following:

- Copper or anodised aluminium
- Hand painted silver or gold leaf crockery
- Wood or bone handled utensils
- Iron or non rust proof utensils
- Plastic items which are not dishwasher safe
- Expensive one such as silvers and dishes with golden rings
- Fragile item such as crystal glasses

1. Cutlery Rack

The cutlery rack is suitable for flatware and most cooking or serving utensils.

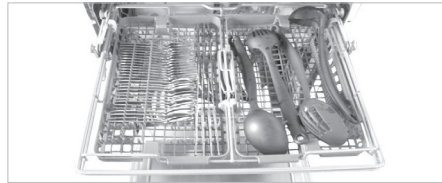

Knife, fork and spoon handles should be positioned between the tines.

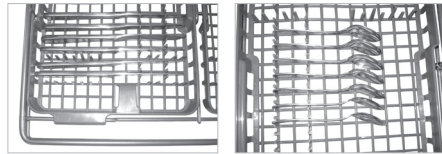

WARNING

- Be careful when loading and unloading sharp-edged items. Load sharp knives with the blade down in order to reduce the risk of injury.

Height Adjustable tray

Each side tray can be adjusted independently to a high or low position to accommodate different sizes of utensils or cutlery.

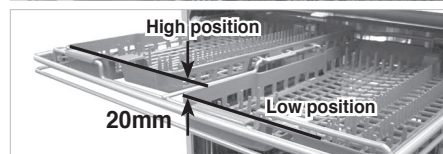
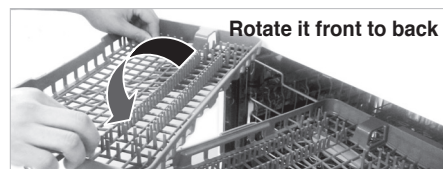
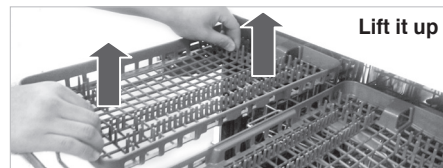

HOW TO USE AND OPERATE

■ Removable Cutlery Rack

The entire cutlery rack can be removed if more space is needed on the upper rack for larger items.

ⓘ NOTE

Always remove cutlery from the rack before removing the rack.

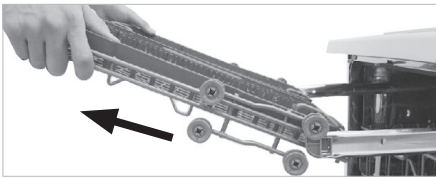

Pull the rack out to the end of the rails, then lift the front of the rack so the rollers clear the stop on the end of the rail. The rack can now be slid forward and removed from the rails.

2. Cutlery Basket

Place forks and spoons in the cutlery basket with their handles downwards.



For Large utensils, such as whisks, the cover can be opened by being unhinged. Take care not to obstruct the rotation of the spray arm.

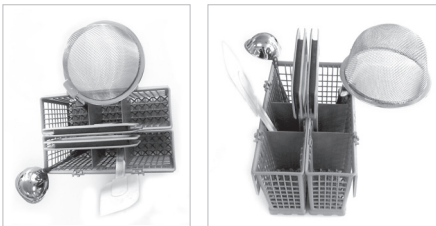

The cutlery shouldn't be longer than 18cm. (In this case, use cutlery rack.)

The basket can be split along its length, increasing the lower rack's loading versatility.

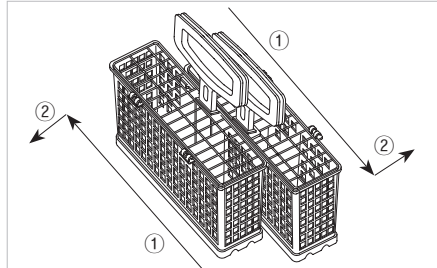

Slide two baskets in opposite directions, then pull them apart.

⚠ WARNING

- To prevent injuries, **place knives and other utensils with sharp points on the cutlery rack.**
- If you want to load them in the cutlery basket, place them with the pointed edges facing downwards.

3. Lower Rack

The lower rack is suitable for dinner plates, soup bowls, dishes, pots, pans, lids and even the grill tray.

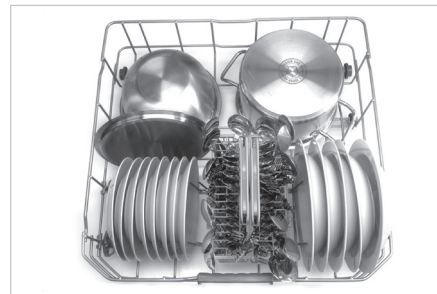

Plates should be positioned upright and facing the centre of the rack and pots, pans and large dishes must be turned upside down.

HOW TO USE AND OPERATE

Take care not to obstruct the rotation of the spray arms.



To make it easier to load larger dishes, the front row of tines can be **folded down**.

■ How to fold down

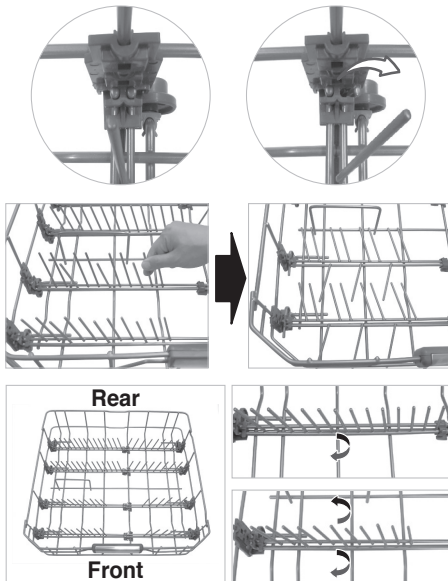

The front side rows are composed with a pair of rows of tines. Each pair can be folded separately to load large dishes, especially bowls. To make the space between two tines wider, fold down the rear row of each pair. Fold down the back side rows of tines to load pots.

• E.g.) Loading dishes

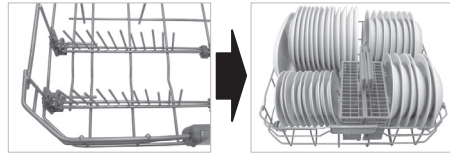

Fold up whole tines.

• E.g.) Loading bowls

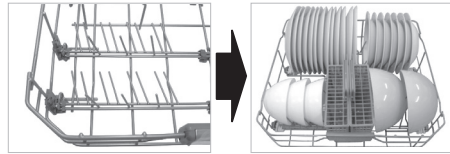

Fold down the rear row of each pair of tines.

• E.g.) Loading pots

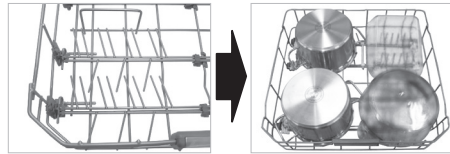

Fold down whole tines.

4. Upper Rack

The upper rack is suitable for delicate items such as, small plates, long cutlery, cups, glasses and dishwasher safe plastic items.

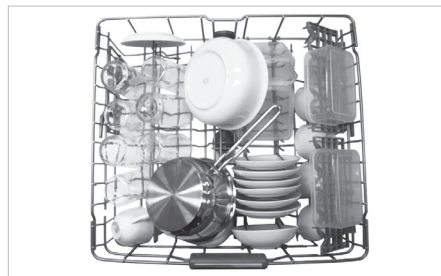

Plates should be positioned upwards with the plate bottom facing the front of the rack. Cups, glasses and bowls must be positioned upside down.

HOW TO USE AND OPERATE

Take care not to obstruct the rotation of the spray arm under the upper rack.

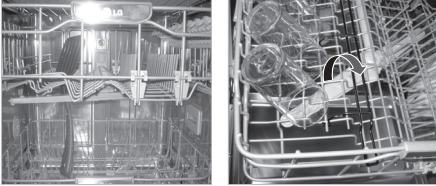

To make it easier to load larger cups or glasses, the left side row of tines can be folded down. For the upper rack's position, dishes shouldn't be larger than 25cm with the upper position, nor 20cm with the lower position.

■ How to fold down

• Pull up the tine

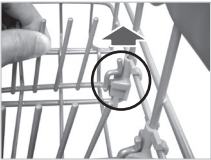

• Rotate the tine

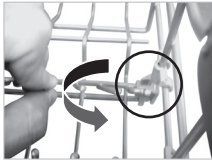

Long stem glassware can be placed without interference from the lowered tines.

The cup racks can be folded up out of the way for tall crockery items.



■ Adjusting the height of the upper rack

The height of the upper rack can be adjusted when you load glasses with long stems or tall crockery items.

• Move the upper rack to the lower position

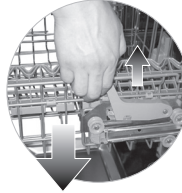

Pull up the levers on either side of the rack.

• Move to upper position



Lift the rack upward.

There is a 45mm gain in height when the upper rack is moved to the lower position.

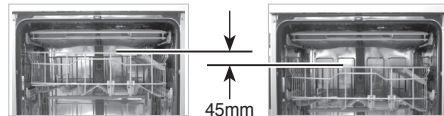

After adjusting the rack levels, check that the spray arms are free to rotate.

⚠ WARNING

• **Before adjusting, ensure the rack is empty of all crockery.** Otherwise crockery may get damaged or you may get injured.

With the lower position of the upper rack, check if the bottom part of upper rack including spray arm is not disturbing items on the lower rack.

• When the upper rack is in the lower position, push in the upper rack first, and the lower rack later.
(Pull out the lower rack first, and the upper rack later.)

HOW TO USE AND OPERATE

5. Adding Detergent

- Detergent must be put into the detergent chamber before starting every programme.
- Please follow the manufacturer's instructions within the manual, when determining the correct amount of detergent to use.
- If your dishes are moderately dirty, you may use slightly less detergent than recommended.
- Chambers hold up to 50g including pre-wash chamber.
- The amount of detergent required depends on the programme. Please refer to the guide table.

PROGRAMME	AMOUNT OF DETERGENT	
	Pre-wash (Onto the door)	Main-wash (Dispenser)
Quick & Dry	5g	20g
Quick	-	10g
Eco	-	35g
Auto	10g	25g
Steam Care	-	20g
Steam Dual Spray	5g	30g
Steam Power	-	35g

- The detergent is dispensed automatically during the operation.
- The chamber lid remains open after operation.

NOTE

Detergent Information

- Use only the detergent intended for household dishwashers. (Ordinary hand-washing detergent should not be used, because the foam will interfere with proper operation.)
- When using some dishwasher tablets, the dispenser may not open due to their excessive size.
- If this happens, place the tablet onto the floor of the tub.

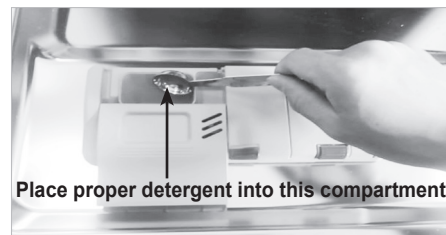

HOW TO USE AND OPERATE

⚠ WARNING

- The detergent used is a special Dishwasher detergent and like all household chemicals it should be treated as harmful and kept out of reach of children.
- **After completion of the wash programme, the detergent compartment should be checked and any remaining detergent removed.**

⚠ CAUTION

Using combined detergent products (ex.3 in 1)

- Some products integrated with rinse aid work best with specific programmes only. You will obtain optimum rinsing and drying results by using conventional rinse aids.
- The use of Dishwasher Tablet products may also cause the soap dispenser to remain shut, therefore failing to dispense the soap tablet. These combined detergent products can alternatively be placed in the filter prior to starting the wash cycle. Please contact the detergent manufacturer if the drying performance is very poor or you find white foam, when you use the combined detergent products. The rinse aid dial should be set to minimum when using wash tablets with built in rinse aid. Excessive rinse aid can cause foaming at the end of the wash. We do not warrant the complaints that are directly related to the use of these products. Do not use liquid rinse aid if using tablets containing a rinse aid agent.

6. Refilling

■ For refilling Rinse Aid

Depending on the dosage setting and the number of washes, the chamber may need to be topped up, approximately once a month. The rinse aid level can be checked by two methods.

- By the indicator window on the dispenser when the dishwasher door is fully open.

- **Black indicates sufficient Rinse Aid**
- **Clear indicates Rinse Aid required**

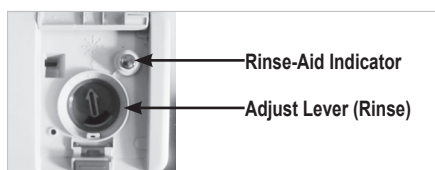

- By the light on the control panel, being lit, when the dishwasher is working on.

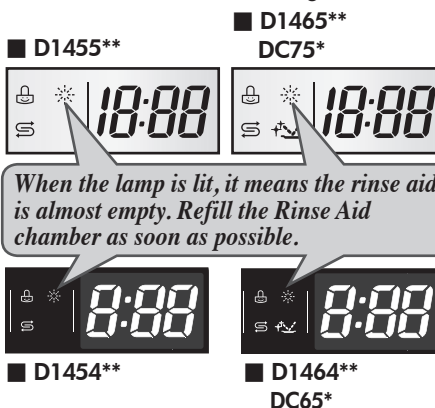

ⓘ NOTE

Rinse Aid Information

- Rinse Aid is necessary to remove spots and streaks of the water from dishes as well as improved drying. Using the correct amount will improve wash performance. However, using too much can produce excess foam leading to possible water leaks.
- Use of an unqualified detergent and rinse aid may present a risk of damage, corrosion, poor washing performance, poor drying, leakage.

HOW TO USE AND OPERATE

■ For refilling Salt

When the salt container is empty, the salt refill lamp will automatically turn on during operation. The salt should be refilled after the cycle has finished. We recommend the salt refill should always be carried out, as mentioned on previous page, prior to starting the next operation. This will immediately thin and drain away any excess salt solution.

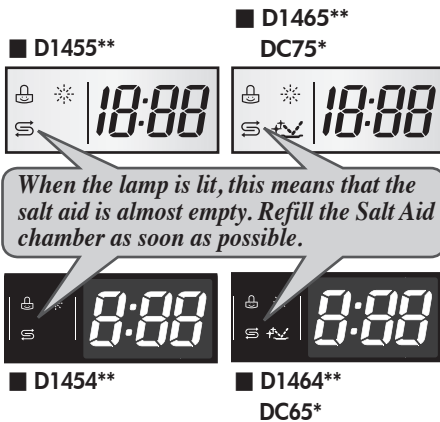

ⓘ NOTE

- After filling with salt, it may take a little while before the indicator light turns off.
- When the control is set to *HD*, it is not necessary to fill up with salt as no salt is consumed while the dishwasher is operating. If the control is set between *H1* and *H7*, then salt must be added to the salt container.

⚠ WARNING

- **Do not pour detergent into the salt container.** This will destroy the water softener.

7. Drying

- To assist drying, we recommend that the door be partially opened after the cycle. The display will indicate Cd (cool dry) for a further 60 minutes after the end of the cycle time. It can be interrupted or terminated by simply opening the door.
- The use of rinse aid is recommended for optimum drying results.
- Select the Extra Hot option to get better drying results.

8. Washing

Remove all dishes, silverware and silverware holder from dishwasher.

Only racks should remain in tub. For best results, use citric acid powder (can be found in canning sections of most grocery stores or online).

Measure 3 tablespoons (45g) of citric acid powder.

Fill main wash compartment with measured powder.

If you cannot find citric acid powder, pour approximately 1 ¾ -2 cups (400-500mL) of white vinegar into shallow bowl and place in lower rack.

Run Auto with Extra Rinse or Rinse+options.

DO NOT USE DETERGENT. After cycle is complete, remove bowl and run a quick cycle to clean tub of any remaining vinegar or citric acid.

OPERATING SEQUENCE

1. Press the Power button

2. Check there is rinse aid and salt

The corresponding indicator lights will illuminate if refilling is required.

3. Open the door and check the filters

Ensure they are clean and properly positioned. (See User Maintenance Instructions)

4. Load the dishes

Remove any excess food.
Pull the lower rack out and arrange the dishes and cutlery.
Pull the upper rack out and arrange the cups, glasses, etc.

⚠ WARNING

Do not load the items in upper rack when the lower rack is pulled out and loaded.
Failure to follow this warning, could result in injury due to the falling dishwasher.

5. Ensure the spray arms can freely rotate

6. Measure out detergent

Add the required amount of detergent into the dispenser and close the lid.

7. Setting and starting the programme

Press the programme button to select the desired programme.
After 10 seconds, the machine will start.
If necessary, select the option function corresponding to the desired programme.
The indicator lights of the programme and all the phases of the programme will come on.
Before starting, the display window shows the running time of the selected programme.

After starting, the display window shows the remaining time.

The time in the display window will start to decrease minute by minute.

If the door is opened during the programme a safety device ensures that the machine stops.

Once the door is re-closed the programme will start from where it was interrupted.

8. At the end of the washing programme

End is displayed on the digital display and a buzzer sounds.

And the dishwasher automatically switches off for safety and energy saving later.

If you select UV function, the dishwasher automatically switches off after sterilising action.

⚠ CAUTION

- **Empty the lower rack first and then the upper one;** this will avoid water dripping from the upper rack onto the dishes below.

⚠ WARNING

- In general it is not advisable to open the door while the machine is working.
- If the door is opened, a safety device ensures that the machine stops.
- Care must be taken if the door is opened during the hot phase or immediately after a programme has finished, as steam may escape.

⚠ CAUTION

- The door should not be left in the open position since this could present a tripping hazard.

PROGRAMME

- ▶ Running time may vary according to the water temperature, water pressure and voltage.
- ▶ Running time doesn't include Cool Dry - 60min.

Programme	WASH		RINSE			DRY	COOL DRY
	Pre Wash	Main Wash	Rinse 1	Rinse 2	Heating Rinse		
Quick & Dry		65°C			70°C		■■■■■■■■
Quick		60°C			65°C		■■■■■■■■
Eco		45°C			51°C		
Auto	<i>The programme sequence is optimised and adapted in accordance with how dirty the dishes are.</i>						
Steam Care		50°C			70°C		■■■■■■■■
Steam Dual Spray	45°C	60°C			70°C		■■■■■■■■
Steam Power	45°C	70°C			70°C		■■■■■■■■

▶ Quick & Dry

This programme offers good washing performance within 60 minutes. To assist drying, we recommend to open the door partially when you see the small amount of wet streaks or drops after the cycle. Opening the door right after the cycle may set the High temperature alarm off.

▶ Quick

Can use for lightly soiled recently used dishes and cutlery.

▶ Eco

This programme offers efficient energy and water consumption for a good washing performance on a normally soiled tableware.

▶ Auto

During the Auto programme, the degree of soiling in the dishes is determined by the amount of clouding to the water. According to the degree of soiling, the programme automatically adjusts the washing time and temperature.

■ Auto Restart

If the dishwasher is turned off by a power failure, it will restart from the position it stopped at adjusting accordingly when you press the **Power** button again.

As a result, the energy and water consumption is kept as low as possible. The “F” on display means that the sensor is sensing the status of the dishwasher.

▶ Steam Care

This cycle adds the gentle power of steam to boost the cleaning power of the delicate cycle. The cycle is adequate for effectively cleaning delicate items like fine china or stemware.

▶ Steam Dual Spray

This cycle washes the upper and lower racks at different spray intensities. The lower rack is washed with a strong spray for hard to clean items, while the upper rack is washed with a medium spray for more delicate items. This provides optimum cleaning performance for mixed loads, including fine china and stemware.

▶ Steam Power

This cycle adds the strong power of steam to boost the cleaning power of the intensive cycle. The cycle is adequate for effectively cleaning strongly polluted items like pots and pans.

USER MAINTENANCE INSTRUCTIONS

To prevent trouble and poor operating, it is important to check filters and spray arms at regular intervals.

■ Keeping the dishwasher

- If you are not using the dishwasher for a long time, run a Quick & Dry cycle without detergent. When the cycle is finished, clean the dishwasher according to the USER MAINTENANCE INSTRUCTIONS to remove the food debris at the bottom of the dishwasher and close the door.

■ Filters

- Remove the lower rack first.
- Turn the mesh filter counterclockwise.
- Take out the mesh filter, upper STS filter and outer filter.
- We recommend to clean them and run the Quick & Dry cycle without detergent at least once a week.
- Replace them in the reverse order.

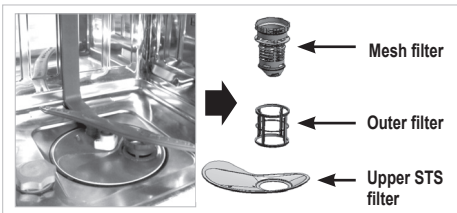

ⓘ NOTE

- After each cycle, clean the filter for a better washing result.
- Before starting, check that the filter is assembled well. If the filter is not assembled correctly, you might have a poor cleaning result.

■ Lower Spray Arm

- Check that the water jet holes are not blocked.
- If cleaning is required, remove the arm by pulling up.
- Clean the spray arm and replace it pulling down.

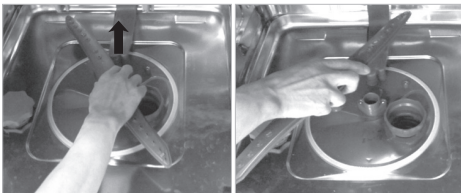

■ Upper Spray Arm

- Pull the upper rack forwards.
- Check that the water jet holes are not blocked.
- If cleaning is required, remove the arm by unscrewing the nut.
- Clean the spray arm and replace it in the reverse order.



■ Water Inlet

- A filter is incorporated in the connection of the valve on the water inlet hose. If insufficient water flows into the dishwasher, check that the filter is not blocked.

• Cleaning the filter

- Disconnect the dishwasher from the mains supply. Switch off at the mains socket and remove the plug.
- Turn off the tap.
- Unscrew the inlet hose.
- Remove the filter from connection.
- Clean the filter in the supply hose under running water.
- Refit the filter, making sure it is sitting correctly.
- Reconnect the inlet hose to the tap.
- Turn on the tap.

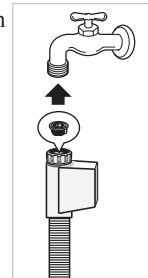

- If there is a leak, the inlet hose might not be on securely, or it may have been screwed on at an angle. Unscrew and reconnect the water inlet valve correctly.
- Reconnect power supply.

TROUBLE SHOOTING GUIDE

- If a problem occurs check below to see whether this can be solved.
- In the unlikely event that the problem cannot be rectified, please contact a service engineer.

■ Before calling for service

Problem	Possible Causes	Solution
No lights come on when the power is turned on.	<ul style="list-style-type: none"> • Plug is not properly inserted into the socket. • Fuses blown or circuit breaker tripped. • The electricity from the house was cut off. 	<ul style="list-style-type: none"> • Check the plug. • Check the electricity. • Call for service.
The control buttons don't be operated except the Power button.	<ul style="list-style-type: none"> • Child Lock function is activated. 	<ul style="list-style-type: none"> • Check the Child Lock indicator. • Press the Child Lock button for 3 seconds to release the Child Lock function.
The machine does not start.	<ul style="list-style-type: none"> • Door is not fully closed. • The start button is not pressed. 	<ul style="list-style-type: none"> • Close the door. • Press the start button.
The spray arms do not rotate smoothly.	<ul style="list-style-type: none"> • The mounting of the spray arms is blocked by food particles. 	<ul style="list-style-type: none"> • Clean the holes of the spray arm.
White deposits are left on the dishwasher after washing.	<ul style="list-style-type: none"> • The amount of detergent or rinse-aid set incorrectly. • The salt container is empty. • The salt container cap is not securely screwed on. 	<ul style="list-style-type: none"> • Check the detergent or rinse-aid. • Check the salt container or cap.
Streaks are left on glassware.	<ul style="list-style-type: none"> • Too little Rinse-Aid dispensed. 	<ul style="list-style-type: none"> • Fill the rinse-aid. • Adjust the level of rinse-aid container.
Dry results are not satisfactory.	<ul style="list-style-type: none"> • Too little Rinse-Aid dispensed. 	
Washing results are not satisfactory.	<ul style="list-style-type: none"> • Incorrect amount of detergent. • Utensils incorrectly arranged or overloaded. • Filters are clogged. • Water jet holes of spray arms blocked. • Spray arm's rotation obstructed by utensils. • Unsuitable programme selected. 	
The leakage occurs at door.	<ul style="list-style-type: none"> • The dishwasher is not correctly leveled. 	<ul style="list-style-type: none"> • Adjust the level of dishwasher.

TROUBLE SHOOTING GUIDE

■ Before calling for service

Problem	Possible Causes	Solution
The display shows OE code. (Water is not pumped away.)	<ul style="list-style-type: none"> • The drain hose is kinked. • The filter is clogged. • Motor trouble. (Washing motor or Drain motor) 	<ul style="list-style-type: none"> • Straighten hose(s). • Clean the filter. • If you can not solve the problem, call for service.
The display shows IE code.	<ul style="list-style-type: none"> • Water is not supplied. • Water tap is not opened. • Water sensor has trouble. 	<ul style="list-style-type: none"> • Check the water tap. • If you can not solve the problem, call for service.
The display shows AE code. (Automatically Drain pump operated.)	<ul style="list-style-type: none"> • Water is leaking from the hose connections. • Damage to the unit has been caused by a water leak. 	<ul style="list-style-type: none"> • Close the water tap and unplug the power plug. • Call for service.
The display shows FE code. (Automatically Drain pump operated.)	<ul style="list-style-type: none"> • Excessive water is supplied, which is more than the normal water level. • There is a problem with the inlet valve. 	
The display shows HE code.	<ul style="list-style-type: none"> • The water heater circuit is damaged. 	
The display shows tE code.	<ul style="list-style-type: none"> • Thermistor trouble or very high inlet water temperature. 	
The display shows LE code.	<ul style="list-style-type: none"> • Motor trouble. 	
The display shows nE code.	<ul style="list-style-type: none"> • Vario motor trouble. 	

TROUBLE SHOOTING GUIDE

- These are not error codes indicating a malfunction.

■ Before calling for service

Code	Description
The display shows PF code	This indicates there was a power failure. This function protects the dishwasher in the event that the power goes out or the power to the unit is disrupted. When power is returned, and a button is pushed, this will display for 3 seconds and then go away.
The display shows Cd code	Cd means Cool-dry. This is an additional drying cycle to assist drying performance. This cycle runs for a further 60 minutes after the course has finished. It can be interrupted at any time by opening the door.
The display shows CL code	CL means Child-Lock. This function is used to lock or unlock the control buttons to prevent all the settings from being changed by a child. It can only be activated during the wash cycle.
The display shows F code	When the unit is displaying F , the sensor is measuring the water clarity. After 5 minutes of sensing (except draining and filling), the unit's display will then show the processing time.
The display shows numbers between 1 ~ 19	This is not an error code, but indicates the setting of the delay start. To cancel the function, turn the power off. To change the course and option, open the door and select another course and option. Countdown will then continue after door is closed again.
Buzzing sound. (High Temperature Alarm)	This is not an error. When you open the door right after heating wash, rinse or dry, buzzing sound would keep on ringing for safety if the inside is heated.
Odor	If the dishwasher is not used daily, we recommend to run a Quick cycle once or twice a day until you have a full load. In case odor still persists, run a vinegar rinse through a Auto cycle by putting 2cup(500ml) of white vinegar in an upright measuring cup in the lower rack, without detergent. We recommend to maintain according to the USER MAINTENANCE INSTRUCTIONS.

TROUBLE SHOOTING GUIDE

NOTE

SMARTDIAGNOSIS™ function is available only for the products with a SMARTDIAGNOSIS™ mark. In case of a mobile phone with static option, the smart diagnosis function might not operate.

■ Using SMARTDIAGNOSIS™

- Only use this feature when instructed to do so by the call centre. The transmission sounds similar to a fax machine, and so has no meaning except to the call centre.
 - SMARTDIAGNOSIS™ can not be activated if the dishwasher does not power up. If this happens, then troubleshooting must be done without SMARTDIAGNOSIS™.
- If you experience problems with your dishwasher, call the Customer information centre. Follow the call centre agent's instructions, and do the following steps when requested:

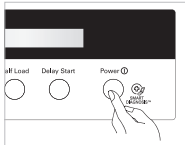

1. Press the Power button to turn on the dishwasher. Do not press any other buttons.

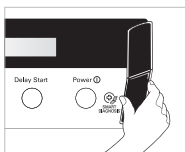

2. When instructed to do so by the call centre, place the mouthpiece of your phone very close to the Power button. (Max. 10mm)

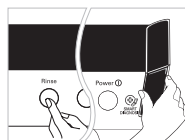
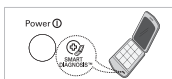

3. Press and hold the Rinse button for three seconds, while holding the phone mouthpiece to the icon or Power button.

4. Keep the phone in place until the tone transmission has finished. This takes about 6 seconds, and the display will count down the time.
 - For best results, do not move the phone while the tones are being transmitted.
 - If the call centre agent is not able to get an accurate recording of the data, you may be asked to try again.
5. Once the countdown is over and the tones have stopped, the machine will display END and turn off automatically after a few seconds. Resume your conversation with the call centre agent, who will then be able to assist you using the information transmitted for analysis at the call to Customer information centre.

- Smart Diagnosis is a troubleshooting feature designed to assist, not replace, the traditional method of troubleshooting through service calls. The effectiveness of this feature depends upon various factors, including, but not limited to, the reception of the cellular phone being used for transmission, any external noise that may be present during the transmission, and the acoustics of the room where the machine is located. Accordingly, LG does not guarantee that Smart Diagnosis would accurately troubleshoot any given issue.

SPECIFICATION

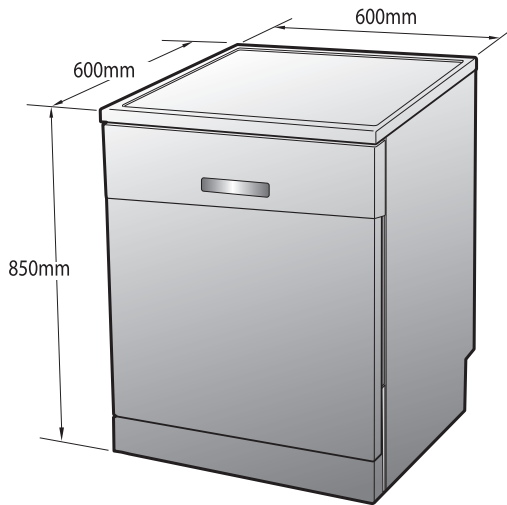

Capacity	14 Place settings
Weight	See rating label
Power Supply	See rating label
Power Consumption	1,900 W 0.49 W (The off mode. The left-on mode)
Water Feed Pressure	50 ~ 800 kPa

